



STOURFLEX

Technically Advanced Flexible Solutions

J&P Supplies Ltd
Junction Road, Audnam,
Stourbridge, West Midlands,
DY8 4YH
Tel: 01384 393329
Fax: 01384 440212
www.stourflex.co.uk

Type JP05 Untied Rubber Bellows High Temperature Water.

Available With Precision Fit Flexible Lagging Jackets To Suit JP05.

Specification Untied WILLBRANDT E.P.D.M. rubber bellows with PEEK reinforced body and collar. Fitted with galvanized carbon steel swivel flanges. Drilled to BS. 4504 NP16.

Application Stourflex untied rubber bellows are designed to reduce noise and vibration imposed on pipework from pumps and reciprocating machinery. The PEEK reinforced body allows the **JP05** to be used on heating systems and cooling applications or where extended service life or higher operating temperatures are required.

Maximum test pressure = 1.5 x working pressure or 1.5 x flange rating, whichever the lower.

Maximum Pressure & Temperature

Up To 110°C	6 Bar
Up To 100°C	8 Bar
Up To 70°C	16 Bar

Lagging

Stourflex are now able to offer a tailor made flexible lagging jacket to help reduce heat gains & condensation on CHW. Please ask for more information.

*We would not recommend the insulation of rubber bellows being used on hot water or heating applications as this can drastically reduce the life expectancy of the bellows leading to premature failure.



Approvals TÜV-SÜD / DIN4809
Certificate No: 18 09 90306 001

Manufacturer



Part Number	N.B. (mm)	Installed Length (mm)	Movement				Pressure	
			Compression (mm)	Extension (mm)	Lateral (mm)	Angular	Working Pressure Up To 70° (bar)	Vacuum
JP05-32-16	32	130	30	30	10	30°	16	Vacuum Support Ring <i>Not-Required</i> .
JP05-40-16	40	130	30	30	10	30°	16	
JP05-50-16	50	130	30	30	10	30°	16	
JP05-65-16	65	130	30	30	10	30°	16	Vacuum Support Ring <i>Not-Required</i> To -300mbar.
JP05-80-16	80	130	30	30	10	30°	16	
JP05-100-16	100	130	30	30	10	20°	16	
JP05-125-16	125	130	30	30	10	20°	16	
JP05-150-16	150	130	30	30	10	20°	16	Vacuum Support Ring <i>Required</i> Below -300mbar.
JP05-200-16	200	130	30	30	10	12°	16	
JP05-250-16	250	130	30	30	10	12°	16	
JP05-300-16	300	130	30	30	10	12°	16	Vacuum Support Ring <i>Required</i> .

Supplied length may vary. Tolerance +/-5%

Where vacuum conditions or pressures and temperatures above those stated exist, please check with us the suitability of and effects on the service life of Stourflex products. Vacuum support ring fitted upon request.

Details on larger sizes and alternative flange specifications are available on request.

Stourflex rubber bellows should be regularly inspected as part of normal system maintenance and replaced immediately if any deterioration is evident. For more information, please contact Stourflex about a site survey.

The **JP05** rubber bellows are produced within the E.E.C and are stamped with date of manufacture.



Installation, Operation and Maintenance Instructions For Rubber Bellows

Storage Rubber bellows should be stored in a cool, dark, clean area and be protected from damage caused by other items of plant and equipment.

Inspection Rubber bellows should be inspected for internal and external damage prior to installation. The rubber bellows sealing surface should be clean and free from any debris that would prevent a seal or cause damage to the bellows in service.

Selection The Stourflex range of rubber bellows are supplied at varying lengths. The movements stated in the datasheet can only be achieved when the given installation lengths are adhered to.

Check that the correct rubber bellows have been selected for the operating conditions that exist. Temperature, pressure and movement should all be confirmed, as the wrong selection may result in failure of the system. Also check whether vacuum conditions exist and if so whether a vacuum support ring is required and has been fitted.

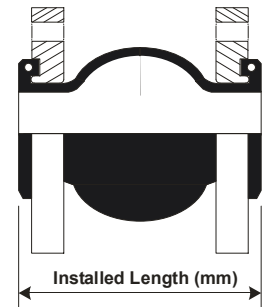

Installation Rubber bellows should be installed at their neutral (supplied) length. Confirm that the gap left between the mating flanges in the pipework corresponds exactly with the neutral (supplied) length of the rubber bellows. Pipework should be true and straight. Any adjustments should be made to the pipework before the rubber bellows are fitted. See appropriate Stourflex data sheets for the installation length of the rubber bellows being installed.

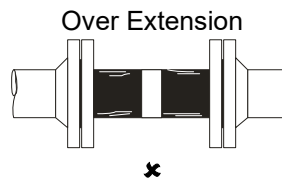
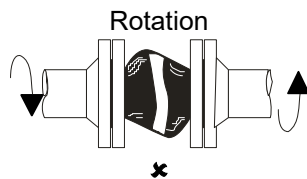
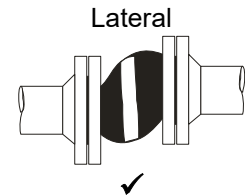
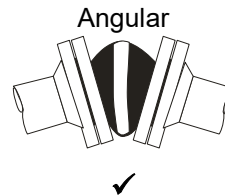
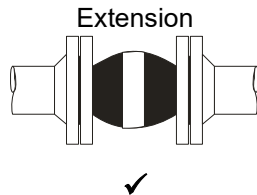
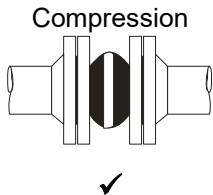

Only the correct mating flanges should be used. They should be the same size and drilling and have a similar sealing face as that of the rubber bellows. They must be clean and free from any debris, sharp edges etc. to prevent damage occurring to the sealing face of the bellows. For mating flanges with a different sealing face diameter a composite gasket should be used to prevent any sharp edges cutting into the rubber sealing face.

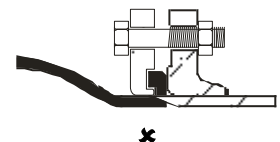
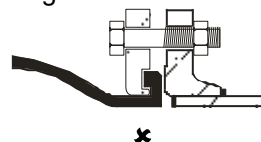
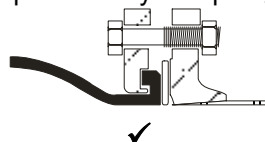
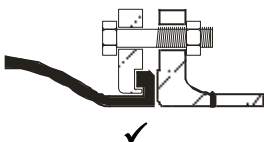

Flange bolts must not be over tightened, bolts should be tightened gradually and evenly and in a crosswise manner. Bolts should be positioned so that the bolt head is nearest the bellows to prevent the bolt damaging the bellow in service. Tightness of bolts should be checked approximately seven days after installation.

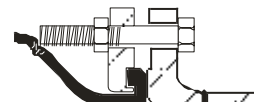
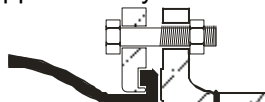

✓ ✘

Installation, Operation and Maintenance Instructions For Rubber Bellows Continued

Installation Continued

When tied rubber bellows are being used they must be installed at their neutral (supplied) length. Recheck installation length and movement capabilities of the bellows being installed. Ensure that the steel washers and the rubber top hat washers have been correctly fitted. Tie bar assemblies should be uniformly tightened and bolts rechecked after approximately seven days.

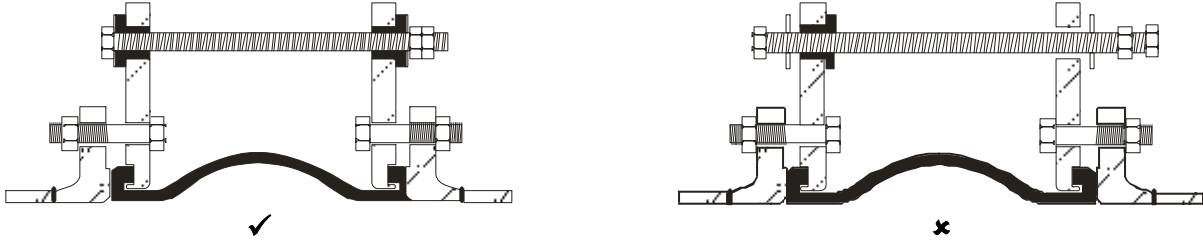

Pressure Test

If a hydraulic pressure test is to be carried out on a system containing rubber bellows, ensure that the anchors are correctly fitting before the test is carried out. Also ensure that the test pressure (usually 1.5 x working) does not exceed the maximum test pressure of the rubber bellows.

Anchoring

Rubber bellows must be anchored to ensure their correct performance. Tied rubber bellows should be selected for the sizes above 80mm and where pressures exceed 3bar.

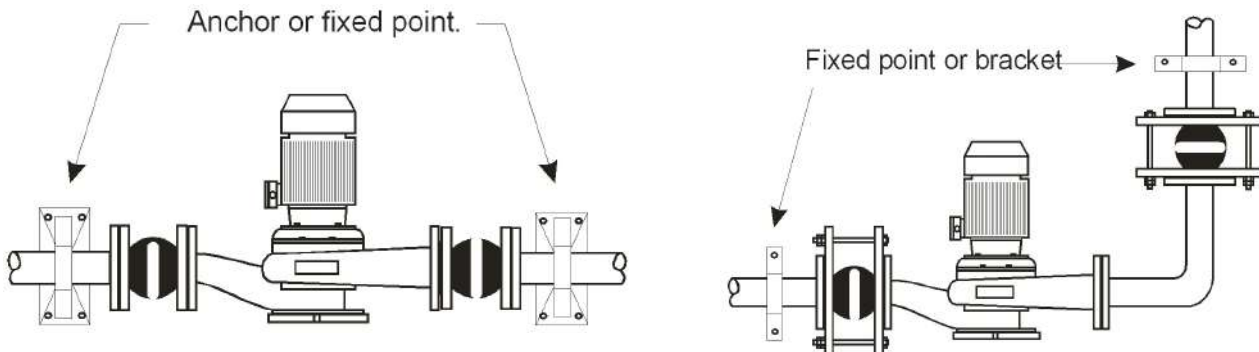

Rubber bellows will exert a pressure thrust in service and must be anchored to protect adjacent pipework and equipment. Rubber bellows will extend under pressure and must be anchored to prevent this happening.



Maintenance

When properly installed and used at their correct operating temperature and pressure, rubber bellows will give many years of trouble free service. However rubber bellows should be inspected periodically for signs of deterioration. If insulation is to be used, this should be removable to allow inspection to be carried out. Flange bolts should be checked and re-tightened if required. Rubber bellows should not be painted as this may reduce service life. If fine hair cracks become evident in bellows membrane this is a sign that the bellows is nearing the end of its service life and should be replaced at the next convenient opportunity. A rubber bellows is an important part of any heating or chilled water system and consideration should be given to keeping a quantity of spares that would prevent a long term shutdown of the system.